



CDME, CDMFE 50Hz

Vertical multistage intelligent variable frequency pump



Stock code:300145



Nanfang Pump Industry Co., Ltd.
CNP Headquarter
Address: Renhe Town, Hangzhou, China
Post code: 311107
Tel:+86-571-86397837,86397810
Fax:+86-571-86397809
E-mail:info@nanfang-pump.com
www.cnppump.com

E200501
subject to amendments



Pumping Water Pumping Honor



Company profile

Nanfang Pump Industry Co.,Ltd (CNP),as a subsidiary of Nanfang Zhongjin Environment Co.,Ltd, was founded in 1991,and listed on Shenzhen Stock Exchange on December 9,2010 with stock code 300145.

In 2019, CNP's annual output exceeded 900,000 units/set with nearly 3 billion sales revenue, continuing to maintain high growth.

As a national enterprise technology center, CNP has flagship ultra-high efficient product -new generation CDM (F) light vertical multistage centrifugal pump, $MEI \geq 0.7$. Same series high temperature pump products are developed in 2019 to satisfy high temperature applications. All light stainless steel pump product series grow stably. Advanced frequency conversion water supply equipment has been innovated to the 6th generation. Fire pump and diesel engine have obtained UL certification. TD in-line pump, NIS/NISO end suction pump, NSC split casing pump, WQ sewage pump, PQ stainless steel fountain submersible pump, BP silent tube pump, pool pump, non-blocking self-priming sewage pump, metering pump, oil pump and other pump products, can meet various application needs of different fields.

CNP has a complete sales network both in domestic and overseas market,exporting to over 60 countries and regions, maintaining long-term and strong relationship with our clients. CNP pumps have been widely applied in various fields like water treatment、water supply and drainage、HVAC、industrial application、seawater desalination、energy and power etc.

CNP, a green water expert beside you.

Content

Performance range	1
Performance table	1
Summary	2
Motor	2
Variable frequency controller	2
Application	2
Curves conditions	2
Operating condition	2
Max.working pressure	2
Function and Features	3
Model definition	4
CDM(F)E1 Performance curves	5
CDM(F)E1 Performance table	6
CDM(F)E3 Performance curves	7
CDM(F)E3 Performance table	8
CDM(F)E5 Performance curves	9
CDM(F)E5 Performance table	10
CDM(F)E10 Performance curves	11
CDM(F)E10 Performance table	12
CDM(F)E15 Performance curves	13
CDM(F)E15 Performance table	14
CDM(F)E20 Performance curves	15
CDM(F)E20 Performance table	16
CDM(F)E32 Performance curves	17
CDM(F)E32 Performance table	18
CDM(F)E42 Performance curves	19
CDM(F)E42 Performance table	20
CDM(F)E65 Performance curves	21
CDM(F)E65 Performance table	22
CDM(F)E1 Installation sketch	23
CDM(F)E3 Installation sketch	24
CDM(F)E5 Installation sketch	25
CDM(F)E10 Installation sketch	26
CDM(F)E15 Installation sketch	27
CDM(F)E20 Installation sketch	28
CDM(F)E32 Installation sketch	29
CDM(F)E42 Installation sketch	30
CDM(F)E65 Installation sketch	31

Performance range

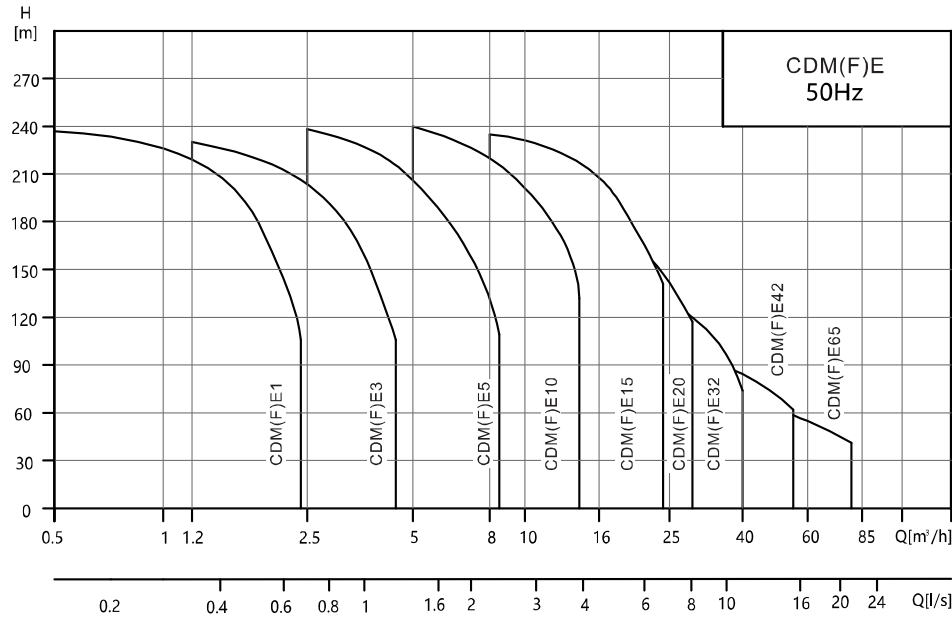

Performance table

Description	Model									
	CDM(F)E									
Rated flow [m³/h]	1	3	5	10	15	20	32	42	65	
Rated flow [l/s]	0.28	0.83	1.39	2.78	4.17	5.56	8.89	11.67	18.06	
Flow range [m³/h]	0.5~2.4	1.2~4.4	2.5~8.5	5~14	8~24	10~29	16~40	25~55	30~80	
Flow range [l/s]	0.14~0.67	0.33~1.22	0.69~2.36	1.39~3.89	2.22~6.67	2.78~8.06	4.44~11.11	6.94~15.28	8.33~22.22	
Max pressure [bar]	24	23	24	24	24	19	14	10	7	
Power [kW]	1.5~2.2	1.5~3	1.5~5.5	1.5~11	2.2~15	2.2~15	1.5~15	3.0~15	4.0~15	
Temp [°C]	-15 ~ +120									
Max. efficiency [%]	48	58	70	72	73	73	73	75	76	
CDME Pipelines	DIN Flange	DN25	DN25	DN32	DN40	DN50	DN50	DN65	DN80	DN100
	Oval flange	G1	G1	G1¼	G1½					
CDMFE Pipelines	DIN Flange	DN25	DN25	DN32	DN40	DN50	DN50	DN65	DN80	DN100
	Cutting ferrule joint	DN32	DN32	DN32	DN50	DN50	DN50			
	Pipe thread	R1¼	R1¼	R1¼	R2	R2	R2			
	Oval flange	G1	G1	G1¼	G1½					

Summary

CDM(F)E series vertical single-stage intelligent variable frequency pump (Hereafter as CDME/CDMFE series or pump) is equipped with intelligent variable frequency controller.

It can realize constant pressure, constant temperature, constant pressure difference and other smart control functions by connecting pressure and temperature sensor. CDME/CDMFE series are energy-saving, low noise, intelligent, environmental friendly with compact structure, beautiful appearance, high reliability, and easy maintenance convenience. Pressure or temperature sensors and other accessories are not in factory configuration. Users need to configure it according to needs.

Motor

TEFC motor, 2-pole standard, three-phase asynchronous motor;
 Protection class : IP55;
 Insulation class : F;
 Standard voltage : 50Hz 3×380V

Variable frequency controller

Input power supply : 50Hz 3×380V
 Power range : 1.5kW~15kW
 Output frequency range : 30Hz~50Hz
 Pressure adjustment range : 0.1bar
 Protection class : Ip55
 Display: LCD

Application

CDME/CDMFE pumps are designed for a variety of applications from the pumping of potable water to the pumping of industrial liquids. Applied for liquids of different temperature, different rated flow, different pressure range. CDME is suitable for non-corrosive liquid, CDMFE is suitable for light corrosive liquid.

Boosting: Filtering and transferring water in water factories, delivering water in different zone, pressuring for major pipelines, boosting for high buildings

Pressuring: Water circulating system, washing system, high pressure flushing system, fire-fighting system

HVAC: Air condition system

Curves conditions

The requirements apply to all the performance curve below:

- All curves are based on the measured value of motor at a constant speed of 2900rpm.
- Curve tolerance in conformity to S9906:2012, grade 3B.
- Measurement is done with 20°C air-free water, kinematic viscosity of 1mm²/s.
- The pump use should refer to the performance range of the bold curve to prevent overheating by too little flow or motor overload by excessive flow.

Operating condition

This pump is applied for thin, clean, non-flammable, non-explosive, solid free, fiber free, physically and chemically water-like liquid.

Liquid temperature: Normal temp -15°C to 70°C;
 Hot water type -15°C to 120°C;

Ambient temperature: up to 40°C
 Altitude: up to 1000m

Max. working pressure

Model	Max pressure
CDM(F)E1, 3, 5, 10 Oval flange	16
CDME32, 42	16(30)
CDME65	16(25)
CDM(F)E1, 3, 5, 10, 15, 20 Flange, Cutting ferrule, Pipe thread	25
CDMFE32, 42	25(30)
CDMFE65	25

Special order is required for pumps with pressure in brackets.

Function and Features

Pump control mode and function can be realized by configuring the communication line between pressure/temperature sensors or controllers in pump, as follows:

- **Control mode:** Five control modes are set in controller: constant pressure mode, constant temperature mode, constant pressure difference mode, constant temperature difference mode and manual mode.
- **Constant pressure mode:** In operation, the pump will enter the shutdown sleep state when the outlet pipeline pressure reaches the set value; the pump will start to operate again when the pressure drops to a certain value.
- **Constant temperature mode:** In operation, the pump will enter the shutdown sleep state when temperature of the outlet pipeline medium reaches the set value; pump will start to operate again when the temperature drops to a certain value.
- **Constant pressure difference mode & Constant temperature difference mode:** When the pump is used for cooling water control, you can choose the constant pressure difference control mode or constant temperature difference control mode. When the inlet and outlet pressure or temperature difference value of cooling equipment reaches the set value, the pump will operate at the lower limit frequency.
- **Function protection:** The Controller is equipped with function protection of high pressure, low pressure, high temperature, low temperature, etc. When actual value exceeds the set value in controller detection system, the controller will send an alarm signal and stop pump from operation automatically.
- ★ **Manual mode:** Controller can make the pump run at the specified frequency by controlling pump start or pump stop and the operating frequency through manual mode.
- ★ **Electrical protection:** Controller is equipped with the protection of over-current, over-voltage, under-voltage, overload and default phase. Facing the electrical fault, the display screen will show the corresponding fault signal and stop the running pump automatically.
- ★ **Restart:** Controller has restart function. When power off in pump running suddenly, the pump will stop; when power on again, the controller can make the pump restart running.
- ★ **Frost proof:** Controller has frost proof function. When the pump is in sleep state, the controller can make pump to operate in low frequency for a period of time in a very low environment temperature condition in the winter to protect pump from being damaged by water freezing .
- ▲ **Multi-pump coordinated operation:** Controller can control the coordinated operation of pumps, achieving at most one main pump, five auxiliary pumps and six pumps coordinated operation for water supply. Various coordinated modes can be adopted to ensure the system's intelligent constant pressure, constant temperature and other water supply modes.
- ▲ **Coordinated mode:** Controller is provided with four coordinated modes: synchronous mode, master-slave mode, large-small pump mode and single-pump operation mode
- ▲ **Synchronous mode:** Main pump and auxiliary pumps operate at the same frequency state.
- ▲ **Master-slave mode:** Main pump is operated in frequency-modulated state, while the other auxiliary pumps are operated in full-frequency state.
- ▲ **Large-small pump mode:** Pump group adopts a small flow pump and multiple large flow pumps . When the system starts or restarts, the small pump is used to run first. When the flow cannot meet the system requirements, the small flow pump will stop and the large flow pump will start instead.
- ▲ **Single pump operation mode:** When the pump group is running, the system adopts a single pump running at any time. (Only applicable to two pumps currently)
- ▲ **Automatic main pump transfer function:** In pump group, when the main pump sensor fail and stop, controller chooses to designate a auxiliary pump as main pump to start and run with main pump functions.
- ▲ **Alternate run:** After pump runs continuously for a long time, alternate run function can be set in controller to balance the pump service life. Running main and auxiliary pumps can act as the main pump in turn according to alternate run time.

Note: Pressure or temperature sensor is required in functions with ● symbol; no requirement of a sensor in functions with ▭ symbol; configuration requirement of the sensor and 485 communication line connection in functions with ▲ symbol.

Model definition

CDM(F)E1,3,5,10,15&20

CDM(F)E 10 - 2

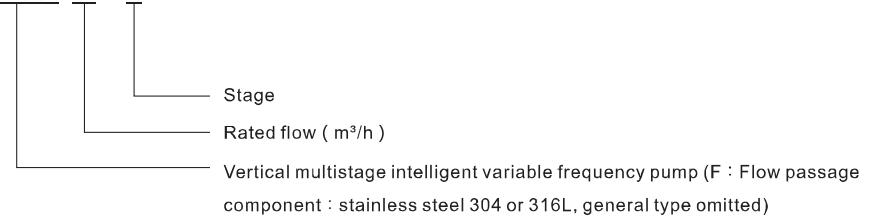

CDM(F)E32 , 42 , 65

CDM(F)E 32 - 3 - 2

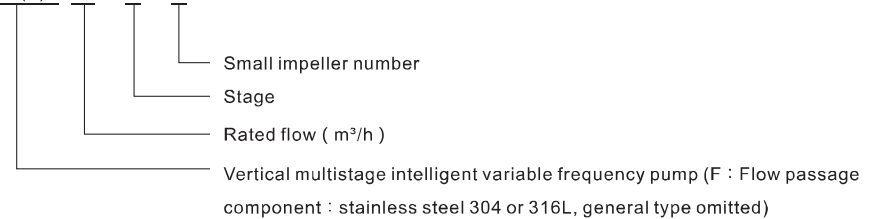

Performance curves

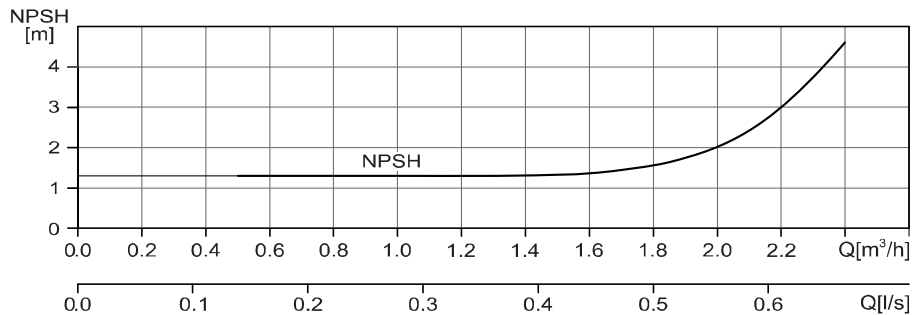
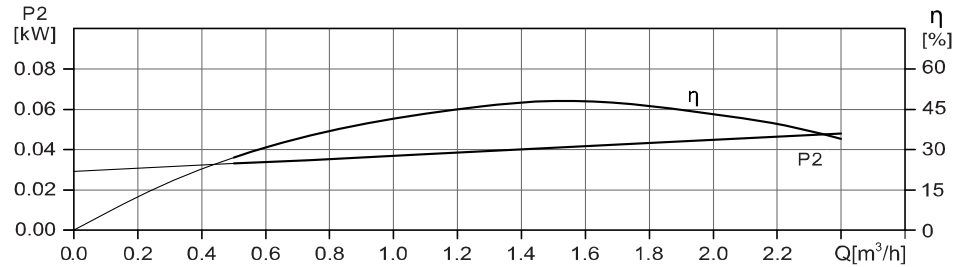
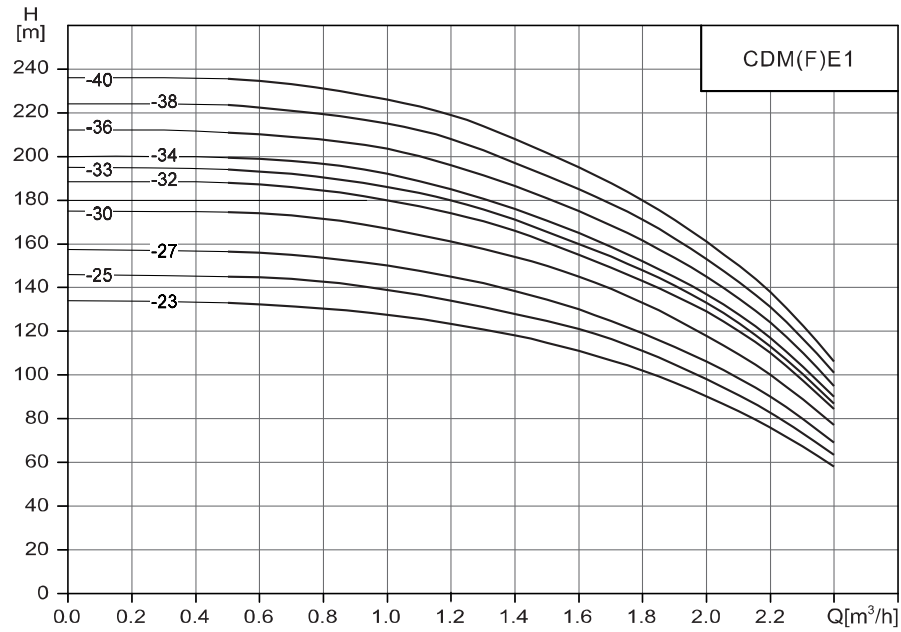

CDM(F)E1 Performance table

Model	Motor (kW)	Q (m³/h)	0	0.5	0.7	1	1.2	1.4	1.6	1.8	2	2.2	2.4
1-23	1.5	H (m)	134	133	132	128	123	118	111	102	90.5	76.5	58
1-25	1.5		146	145	144	139	134	128	121	111	98	83	63
1-27	1.5		158	157	155	150	145	138	130	119	106	90	69
1-30	1.5		175	174	172	167	161	154	145	133	118	100	77
1-32	2.2		189	188	186	180	174	166	155	143	129	110	85
1-33	2.2		195	194	192	186	180	171	160	148	133	113	87
1-34	2.2		200	199	198	192	185	176	165	152	137	117	90
1-36	2.2		212	211	209	203	196	186	175	161	145	124	95
1-38	2.2		225	224	221	215	208	197	185	171	153	131	101
1-40	2.2		237	236	233	226	219	208	195	180	161	138	106

Performance curves

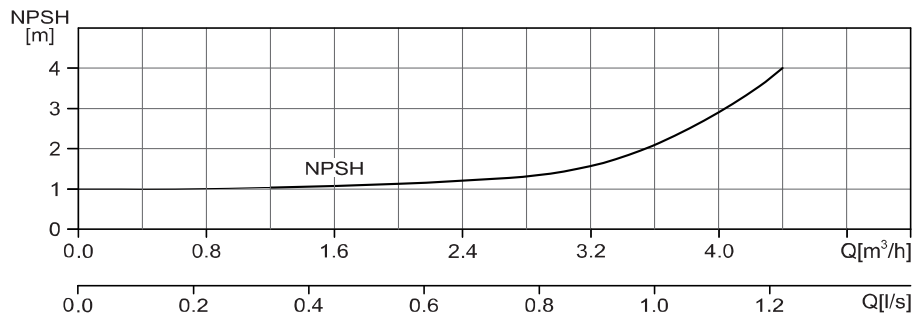
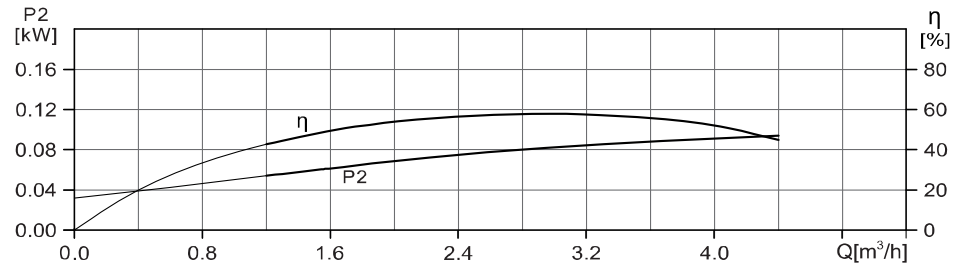
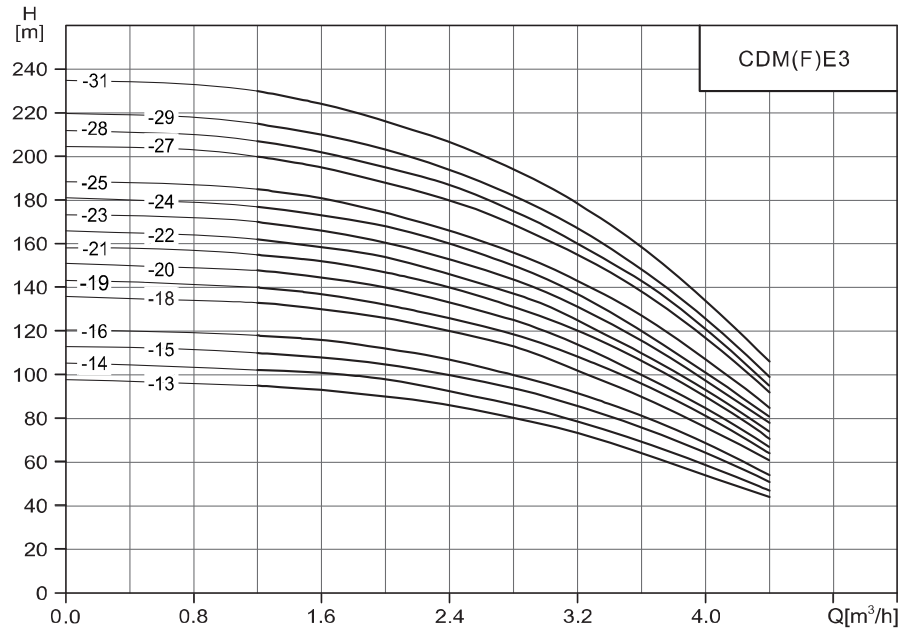

CDM(F)E3 Performance table

Model	Motor (kW)	Q (m³/h)	0	1.2	1.6	2	2.4	2.8	3	3.2	3.6	4	4.4
3-13	1.5	H (m)	98	95	93	90	86	80	77	73	64	54	44
3-14	1.5		105	102	101	98	92.5	86	83	78	69	58	47
3-15	1.5		113	110	108	105	100	94	90	86	76	64	51
3-16	1.5		120	118	116	112	107	100	96	92	81	69	54
3-18	2.2		136	133	130	126	120	113	108	102	90	76	61
3-19	2.2		143	140	137	132	126	119	114	108	96	82	64
3-20	2.2		151	148	144	140	133	125	120	114	100	85	67
3-21	2.2		158	155	152	147	140	131	126	120	106	90	71
3-22	2.2		166	162	158	154	146	137	132	125	110	93	74
3-23	2.2		173	170	166	161	153	144	138	131	115	97	78
3-24	2.2		181	177	173	168	160	150	144	137	120	101	81
3-25	3		188	185	181	175	166	156	150	142	125	105	85
3-27	3		204	200	195	188	180	169	162	155	138	117	92
3-28	3		212	207	202	195	187	175	168	160	143	121	95
3-29	3		220	215	210	203	194	182	175	167	148	126	99
3-31	3		235	230	224	216	207	194	187	178	159	134	106

Performance curves

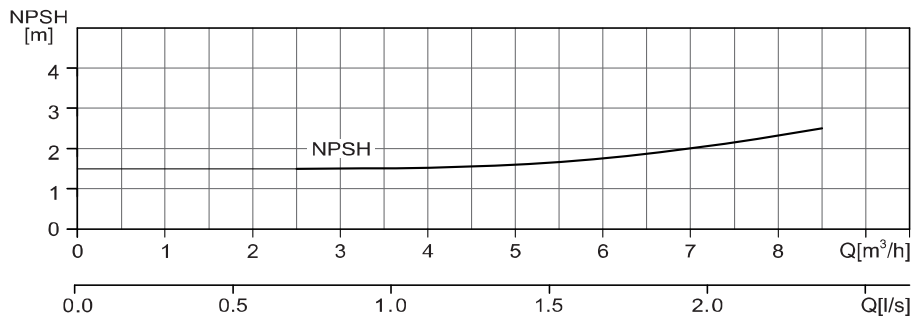
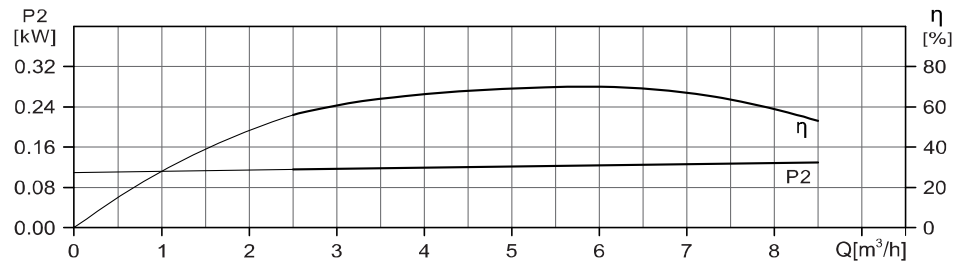
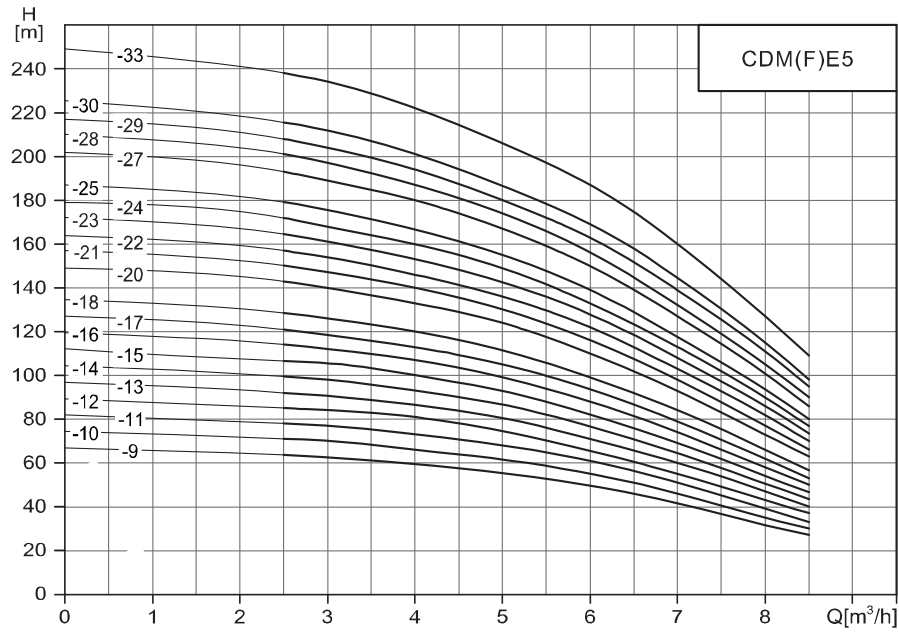

CDM(F)E5 Performance table

Model	Motor (kW)	Q (m³/h)	0	2.5	3	4	5	6	7	8	8.5
5-9	1.5	H (m)	67	64	63	60	55	49.5	41.5	31.5	27
5-10	1.5		74.5	71	70	66	62	55	46	35	30
5-11	1.5		82	78	77	73	68	61	51	39	33
5-12	2.2		89.5	85	84	81	74.5	66	55	43	37
5-13	2.2		97	92	91	87	80	71	60	47	40
5-14	2.2		104	100	98	93	87	77	65	51	43.5
5-15	2.2		112	107	106	100	93	82	69	54	46.5
5-16	2.2		119	114	112	107	99	88	74	58	50
5-17	3		127	121	118.5	113	105	94	79	62	53
5-18	3		134	128	126	120	111	99	84	66	56
5-20	3		149	143	140	133	124	110	93	73	63
5-21	3		157	150	147	140	130	116	98	77	66
5-22	4		164	157	154	146	136	122	103	82	70
5-23	4		172	165	161	153	142	128	108	86	74
5-24	4		179	172	168	160	149	133	113	90	77
5-25	4		187	179	175	167	155	139	117	93	80
5-27	4		202	193	189	180	168	150	127	101	86
5-28	4		210	201	197	187	174	156	132	105	90
5-29	5.5		217	208	204	194	180	163	139	111	95
5-30	5.5		225	216	212	201	186	169	144	115	98
5-33	5.5	249	238	234	222	206	187	160	127	109	

Performance curves

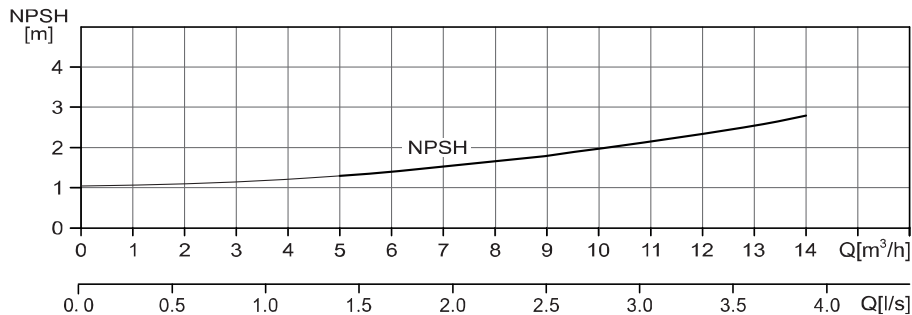
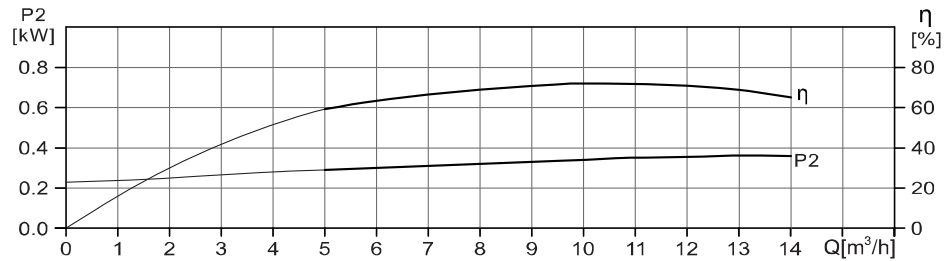
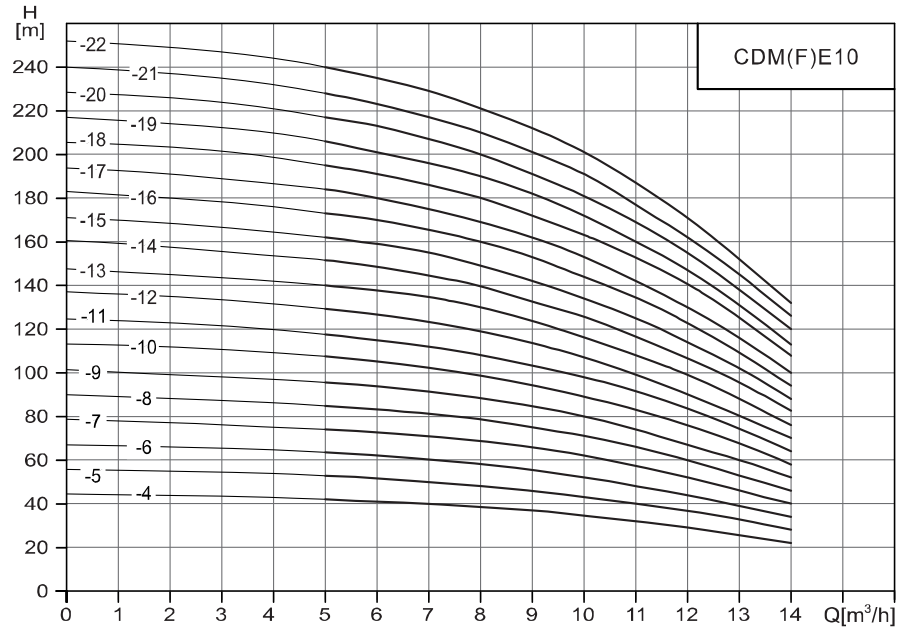

CDM(F)E10 Performance table

Model	Motor (kW)	Q (m³/h)	0	5	6	8	10	12	14
10-4	1.5	H (m)	44.5	42	41	38	34	29	22
10-5	2.2		56	52.5	51	48	43	37	28
10-6	2.2		67	63	62	58	52	44	34
10-7	3		78.5	74	73	69	62	52	40
10-8	3		90	85	84	79	71	60	46
10-9	4		101.5	96	94	89	80	67	52
10-10	4		113	107	105	98	89	76	58
10-11	4		124	118	115	108	98	84	64
10-12	4.5		137	129	127	119	107	91	70
10-13	5.5		147	140	138	130	116	99	76
10-14	5.5		160	151	148	139	125	106	82
10-15	5.5		171	162	159	149	134	114	88
10-16	7.5		183	173	170	159	144	123	94
10-17	7.5		194	184	180	169	153	130	100
10-18	7.5		205	195	191	180	163	141	108
10-19	7.5		217	206	201	190	172	147	113
10-20	7.5		228	217	213	200	181	155	120
10-21	7.5		240	228	223	210	191	162	126
10-22	11		250	240	235	221	201	171	132

Performance curves

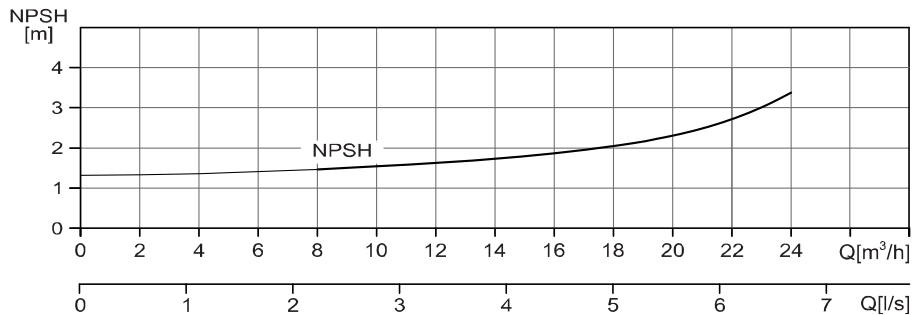
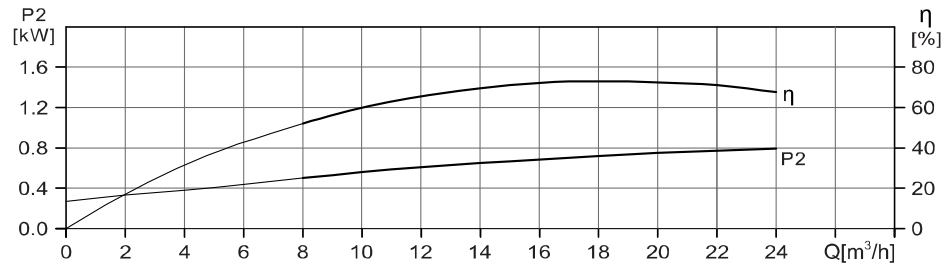
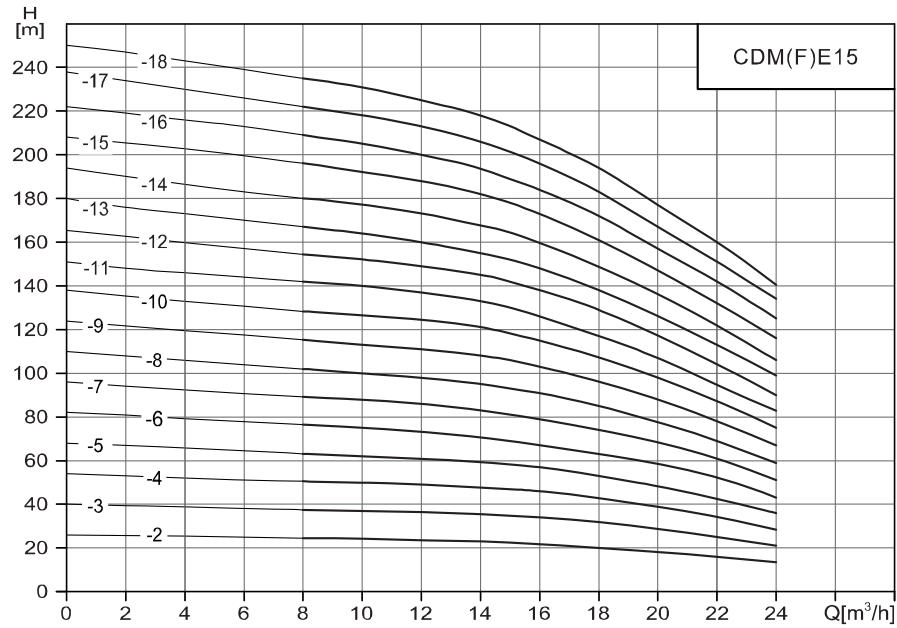

CDM(F)E15 Performance table

Model	Motor (kW)	Q (m³/h)	0	8	10	12	14	15	16	18	20	22	24
15-2	2.2	H (m)	26	24.5	24	23.5	23	22.5	21.5	20	18	16	13.5
15-3	3		40	37.5	37	36.5	35.5	34.5	34	32	29	25	21
15-4	4		54	50.5	50	49	47.5	47	46	43	39	34	28.5
15-5	4		68	63	62	61	59	58	57	53	48	42.5	36
15-6	5.5		82	76	75	73	71	69	67	63	58	52	43
15-7	5.5		96	89	88	86	83	81	79	74	68	61	51
15-8	7.5		110	102	100	98	95	93	91	85	78	69	59
15-9	7.5		124	115	113	111	108	106	103	96	88	78	67
15-10	11		138	128	126	124	121	118	115	107	98	87	75
15-11	11		151	142	140	137	133	130	126	117	107	95	83
15-12	11		166	154	152	149	145	142	138	129	117	104	90
15-13	11		180	167	164	160	155	152	148	138	126	113	99
15-14	11		194	180	177	173	168	165	160	149	136	122	106
15-15	15		208	196	192	188	182	178	173	161	147	132	116
15-16	15		222	209	205	200	194	189	184	172	157	142	125
15-17	15		236	222	218	213	206	201	196	183	167	151	132
15-18	15		250	235	231	225	218	213	207	194	177	160	141

Performance curves

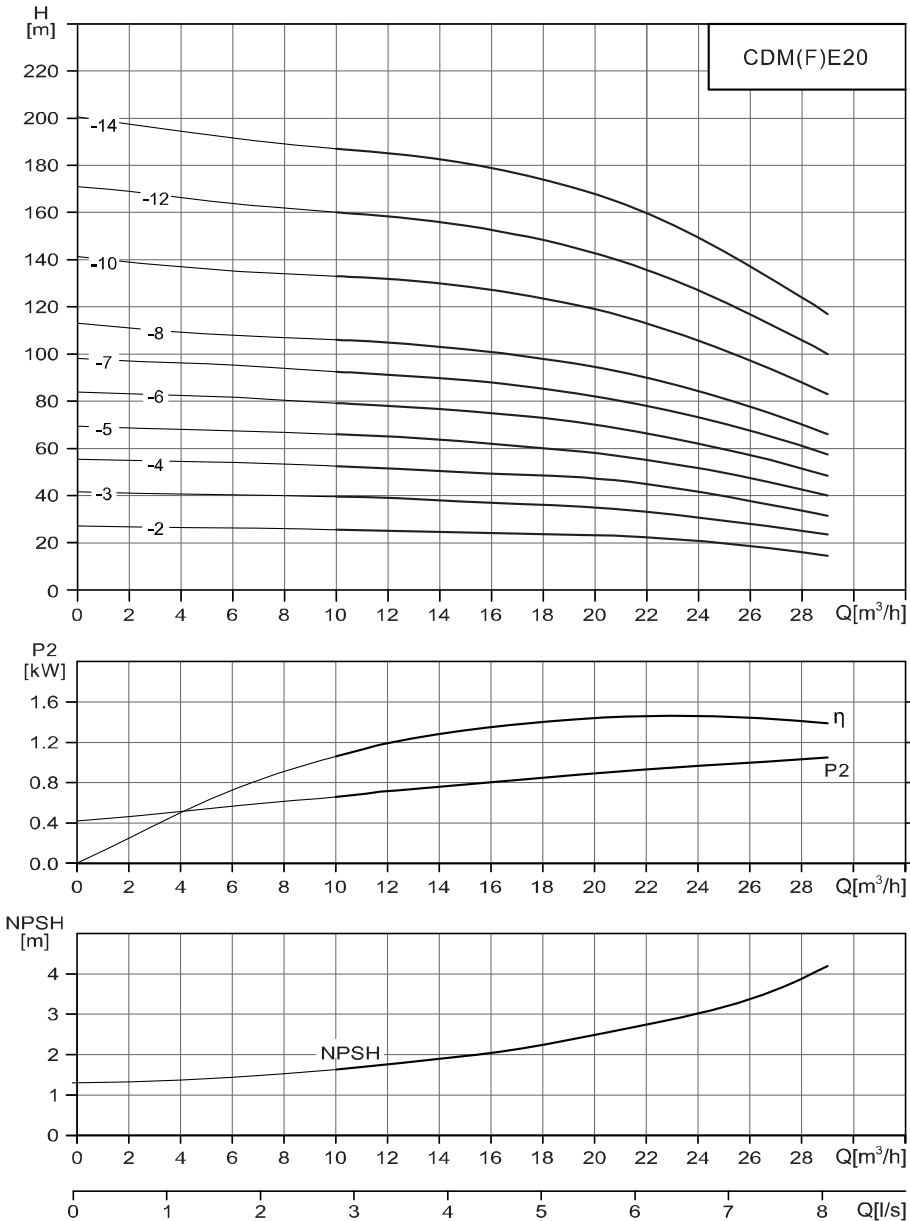

CDM(F)E20 Performance table

Model	Motor (kW)	Q (m³/h)	0	10	12	14	16	18	20	22	24	26	28	29
20-2	2.2	H (m)	27.2	25.5	25	24.5	24	23.7	23	22	20.5	18	16	14.5
20-3	4		41.5	39.5	39	38	37	36	35	33	31	28	25	23.5
20-4	5.5		55.5	52.5	51	50	49	48.5	47	45	41.5	37	33	31.5
20-5	5.5		69.5	66	65	64	62	60	58	55	51	47	42	40
20-6	7.5		84	79	78	77	75	73	70	66	62	58	52	48
20-7	7.5		98	92.5	91	90	88	85	82	78	73	68	61	57.5
20-8	11		113	106	105	103	101	98	95	90	84	77	70	66
20-10	11		141	133	132	130	127	123	119	113	106	97	88	83
20-12	15		171	160	158	156	153	149	143	137	127	117	106	100
20-14	15		200	187	185	183	179	174	168	160	149	137	124	117

Performance curves

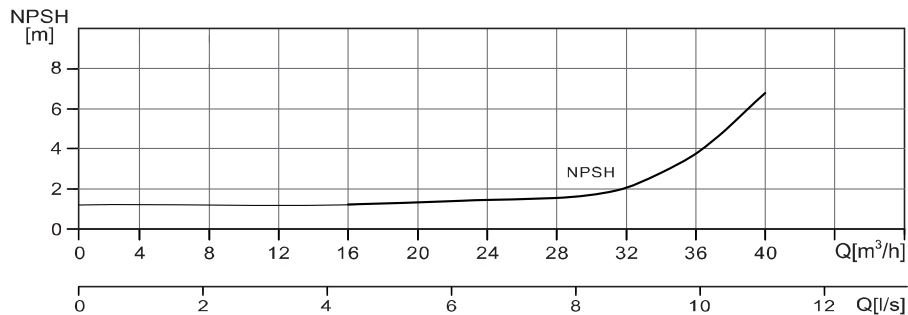
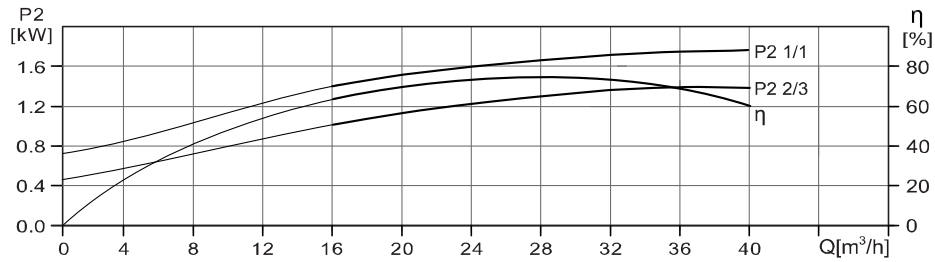
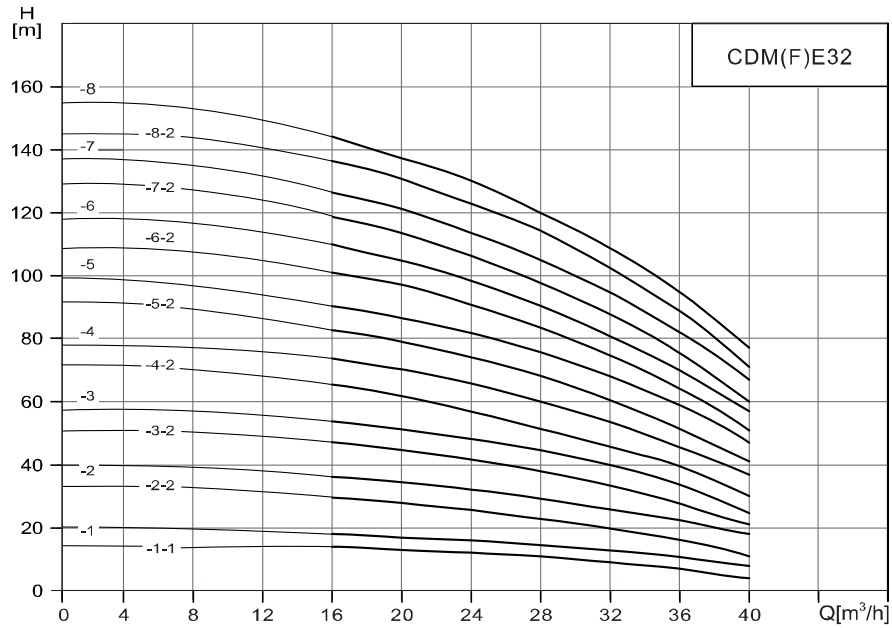

CDM(F)E32 Performance table

Model	Motor (kW)	Q (m³/h)	0	16	20	24	28	32	36	40
32-1-1	1.5	H (m)	15	14	13	12	11	9	7	4
32-1	2.2		20	18	17	15	14	13	11	8
32-2-2	3.0		33	29	28	26	23	20	16	11
32-2	4.0		40	36	34	32	29	27	23	18
32-3-2	5.5		50	47	44	41	38	33	28	21
32-3	5.5		57	54	51	48	44	40	35	27
32-4-2	7.5		72	65	62	58	53	46	40	30
32-4	7.5		78	72	69	65	59	53	47	37
32-5-2	11		92	83	79	74	68	60	52	41
32-5	11		99	90	86	81	74	67	59	47
32-6-2	11		108	101	97	90	83	74	65	51
32-6	11		118	108	104	97	90	81	72	57
32-7-2	15		129	119	114	107	98	88	78	60
32-7	15		138	126	121	113	105	95	85	67
32-8-2	15		145	136	131	123	114	102	90	71
32-8	15		154	144	138	130	120	109	97	77

Performance curves

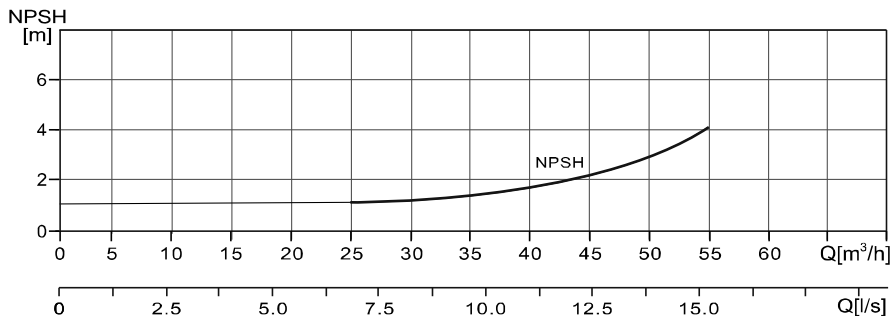
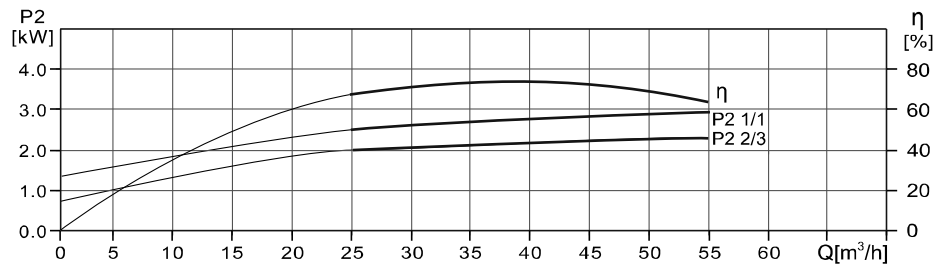
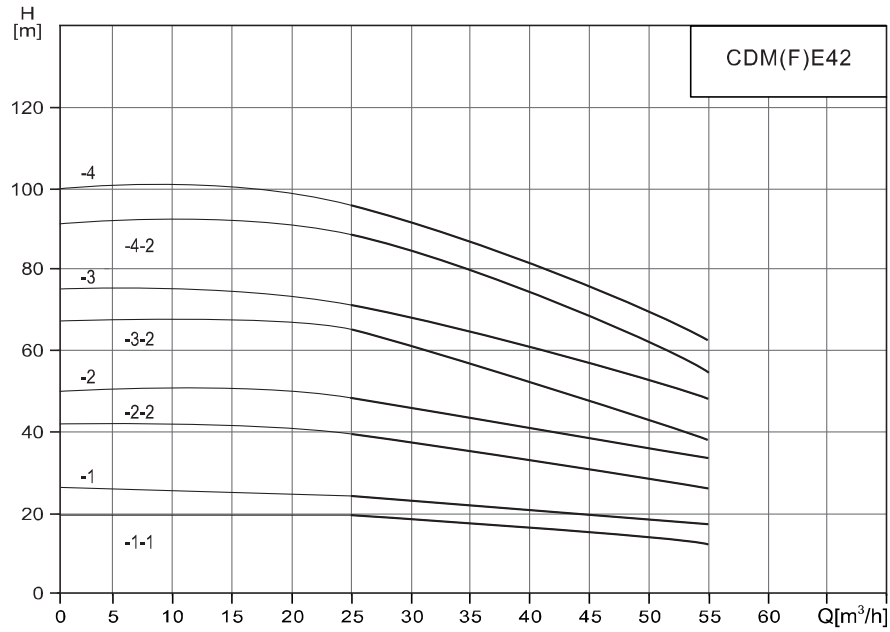

CDM(F)E42 Performance table

Model	Motor (kW)	Q (m³/h)	0	25	30	35	40	42	45	50	55
42-1-1	3.0	H (m)	20	20	19	18	17	16	15	13	11
42-1	4.0		27	24	23	22	21	20	19	18	16
42-2-2	5.5		42	40	38	36	33	32	30	27	23
42-2	7.5		50	48	46	44	42	41	39	35	31
42-3-2	11		66	63	61	58	54	52	50	44	38
42-3	11		75	71	69	66	63	61	58	53	47
42-4-2	15		92	87	84	80	75	73	69	62	54
42-4	15		100	95	92	88	84	81	78	71	62

Performance curves

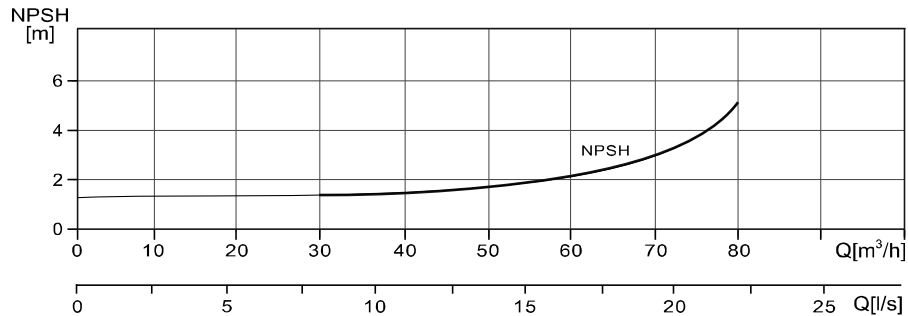
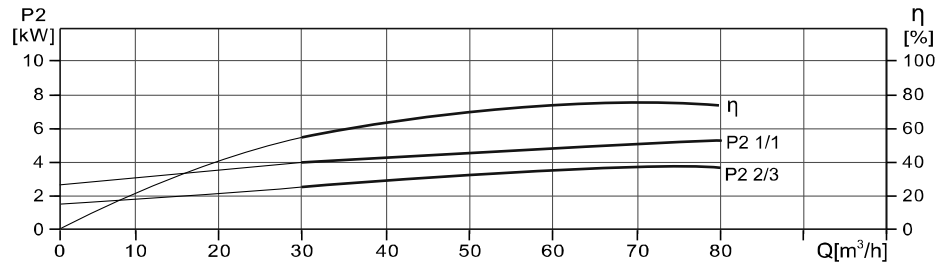
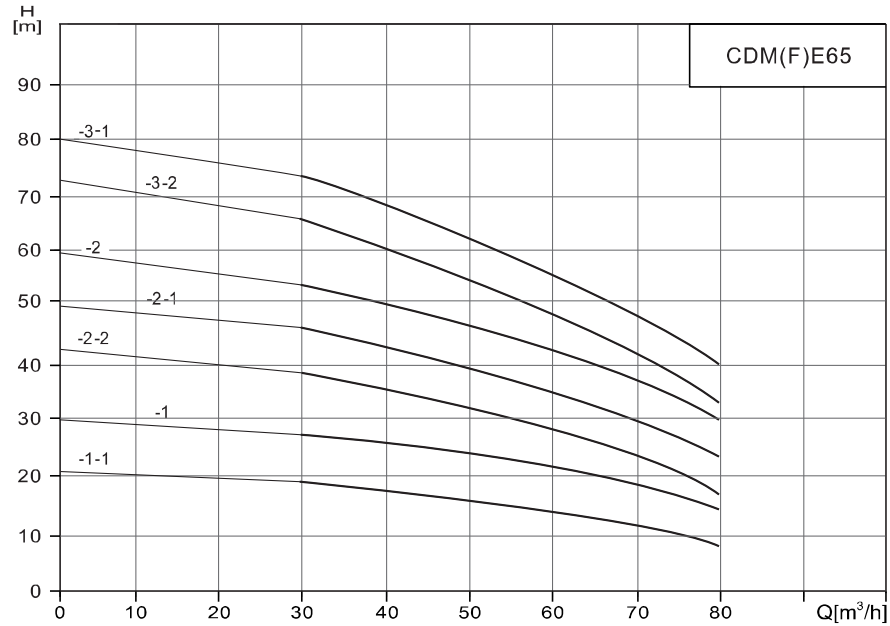

CDM(F)E65 Performance table

Model	Motor (kW)	Q (m³/h)	0	30	40	50	60	65	70	80
65-1-1	4.0	H (m)	20	19	18	16	14	13	11	8
65-1	5.5		30	27	25	23	21	20	18	15
65-2-2	7.5		42	39	36	33	29	26	23	17
65-2-1	11		50	46	44	40	36	33	30	24
65-2	11		60	53	51	47	43	40	37	30
65-3-2	15		73	66	62	56	50	46	41	32
65-3-1	15		80	73	69	63	57	53	48	39

CDM(F)E1 Installation sketch

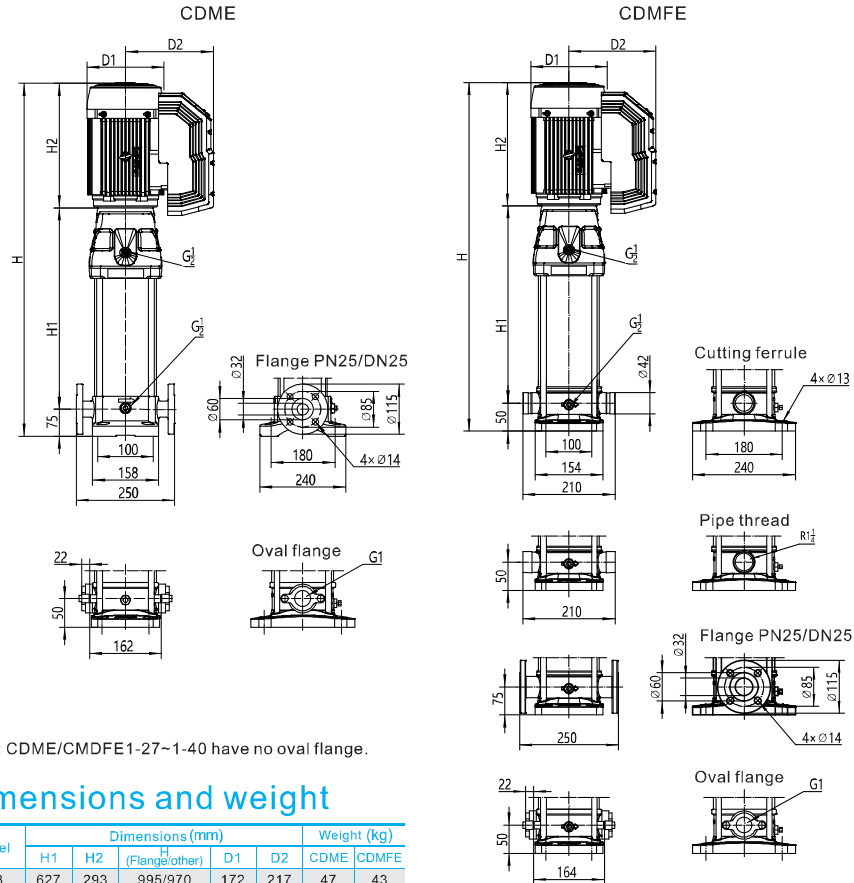

Note: CDM(E)/CMDFE1-27~1-40 have no oval flange.

Dimensions and weight

Model	Dimensions (mm)				Weight (kg)		
	H1	H2	(Flange/other)	D1	D2	CDME	CDMFE
1-23	627	293	995/970	172	217	47	43
1-25	667	293	1035/1010	172	217	48	44
1-27	707	293	1075/1050	172	217	49	45
1-30	767	293	1135/1110	172	217	50	46
1-32	807	293	1175/1150	172	217	53	49
1-33	827	293	1195/1170	172	217	53	49
1-34	847	293	1215/1190	172	217	54	50
1-36	887	293	1255/1230	172	217	55	51
1-38	927	293	1295/1270	172	217	55	51
1-40	967	293	1335/1310	172	217	56	52

CDM(F)E3 Installation sketch

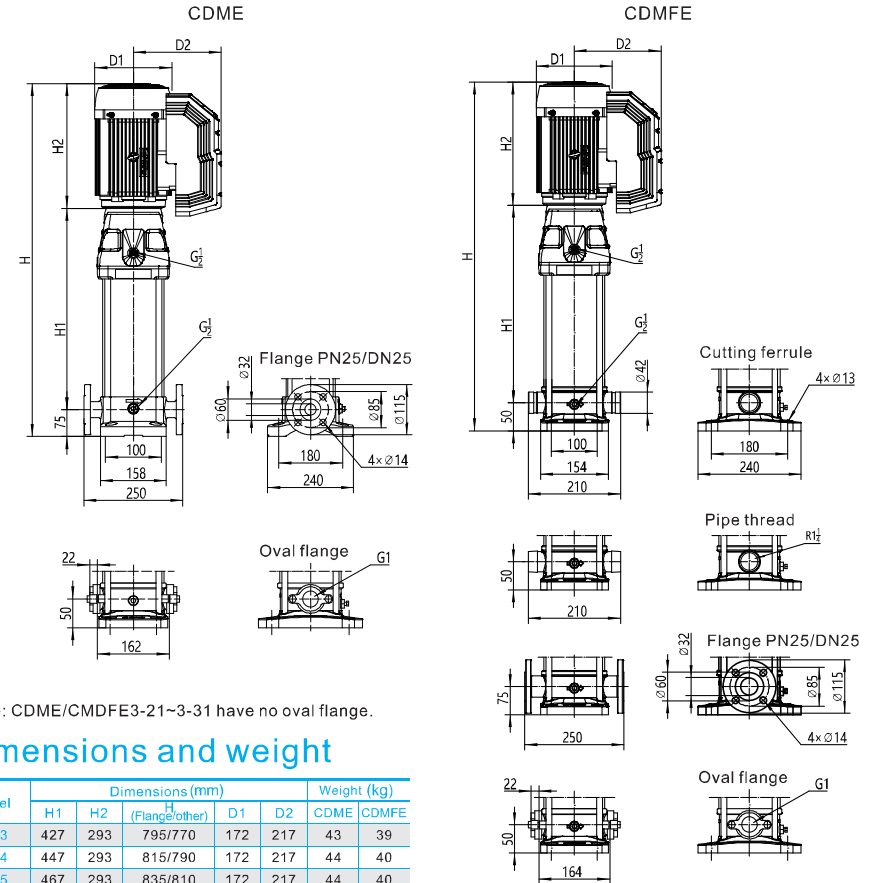

Note: CDM(E)/CMDFE3-21~3-31 have no oval flange.

Dimensions and weight

Model	Dimensions (mm)					Weight (kg)	
	H1	H2	(Flange/other)	D1	D2	CDME	CDMFE
3-13	427	293	795/770	172	217	43	39
3-14	447	293	815/790	172	217	44	40
3-15	467	293	835/810	172	217	44	40
3-16	487	293	855/830	172	217	45	41
3-18	527	293	895/870	172	217	47	43
3-19	547	293	915/890	172	217	48	44
3-20	567	293	935/910	172	217	48	44
3-21	587	293	955/930	172	217	49	45
3-22	607	293	975/950	172	217	49	45
3-23	627	293	995/970	172	217	50	46
3-24	647	293	1015/990	172	217	50	46
3-25	677	345	1097/1072	197	227	61	57
3-27	717	345	1137/1112	197	227	62	58
3-28	737	345	1157/1132	197	227	62	58
3-29	757	345	1177/1152	197	227	62	58
3-31	797	345	1217/1192	197	227	63	59

CDM(F)E5 Installation sketch

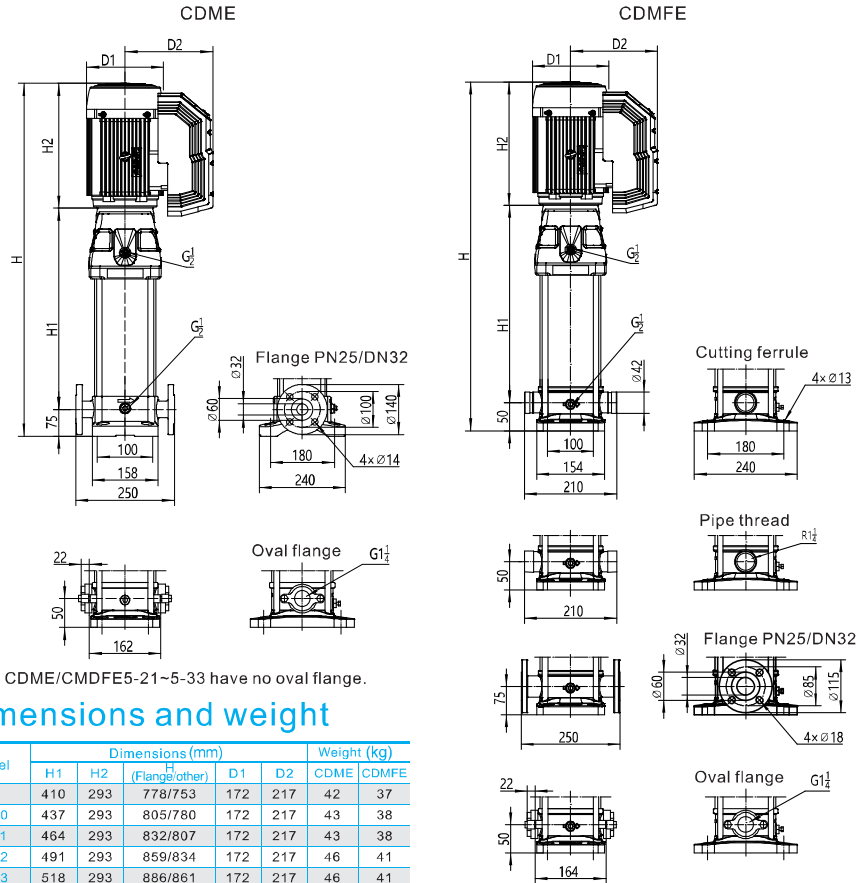

Dimensions and weight

Model	Dimensions (mm)				Weight (kg)		
	H1	H2	(Flange/other)	D1	D2	CDME	CDMFE
5-9	410	293	778/753	172	217	42	37
5-10	437	293	805/780	172	217	43	38
5-11	464	293	832/807	172	217	43	38
5-12	491	293	859/834	172	217	46	41
5-13	518	293	886/861	172	217	46	41
5-14	545	293	913/888	172	217	47	42
5-15	572	293	940/915	172	217	47	42
5-16	599	293	967/942	172	217	48	43
5-17	636	345	1056/1031	197	227	59	54
5-18	663	345	1083/1058	197	227	59	54
5-20	717	345	1137/1112	197	227	60	55
5-21	744	345	1164/1139	197	227	61	56
5-22	771	348	1194/1169	215	245	69	64
5-23	798	348	1221/1196	215	245	70	65
5-24	825	348	1248/1223	215	245	70	65
5-25	852	348	1275/1250	215	245	71	66
5-27	906	348	1329/1304	215	245	72	67
5-28	933	348	1356/1331	215	245	72	67
5-29	1035	390	1500/1475	260	263	92	87
5-30	1062	390	1527/1502	260	263	93	88
5-33	1143	390	1608/1583	260	263	94	89

CDM(F)E10 Installation sketch

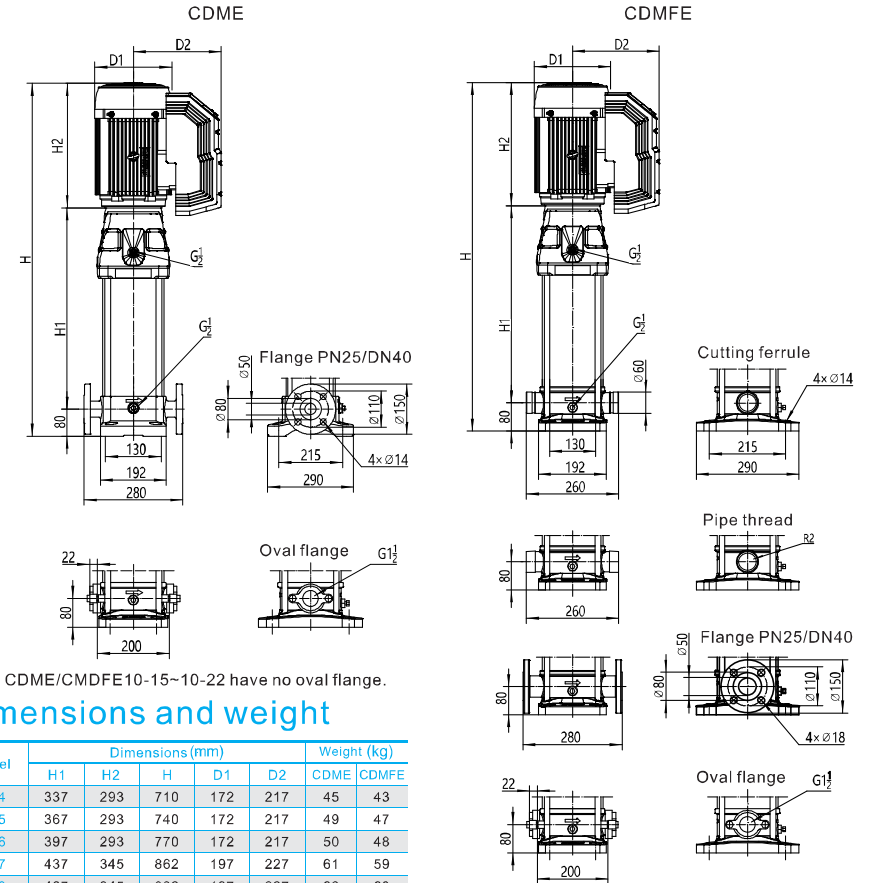

Dimensions and weight

Model	Dimensions (mm)				Weight (kg)		
	H1	H2	H	D1	D2	CDME	CDMFE
10-4	337	293	710	172	217	45	43
10-5	367	293	740	172	217	49	47
10-6	397	293	770	172	217	50	48
10-7	437	345	862	197	227	61	59
10-8	467	345	892	197	227	62	60
10-9	497	348	925	215	245	70	68
10-10	527	348	955	215	245	71	69
10-11	557	348	985	215	245	72	70
10-12	587	348	1015	215	245	73	71
10-13	695	390	1165	260	263	93	91
10-14	725	390	1195	260	263	94	92
10-15	755	390	1225	260	263	95	93
10-16	785	390	1255	260	263	104	102
10-17	815	390	1285	260	263	105	103
10-18	845	390	1315	260	263	106	104
10-19	875	390	1345	260	263	107	105
10-20	905	390	1375	260	263	108	106
10-21	935	390	1405	260	263	109	107
10-22	995	500	1575	330	325	178	176

CDM(F)E15 Installation sketch

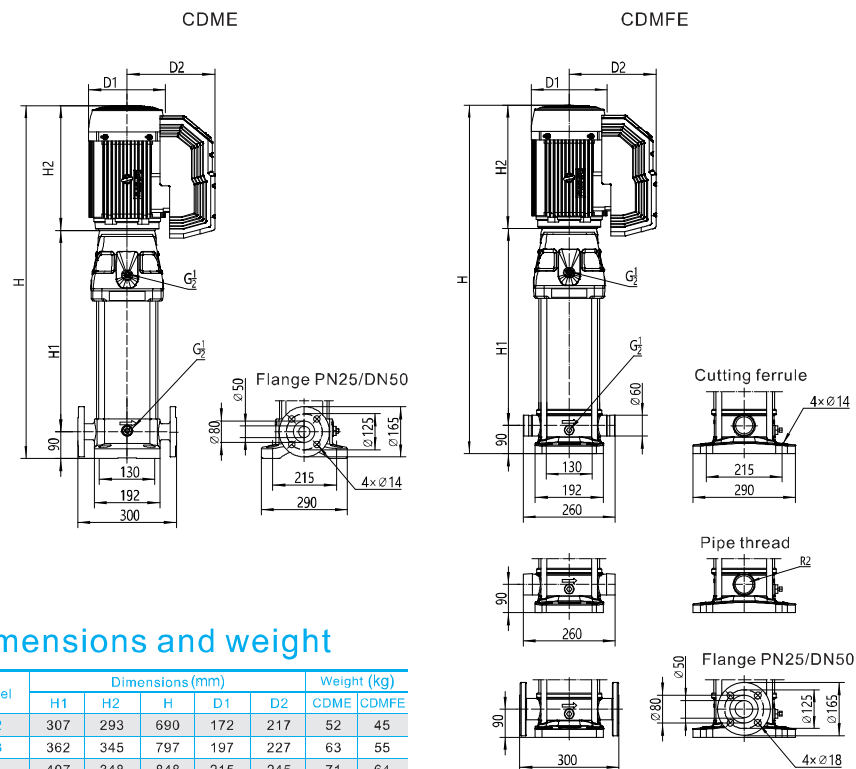

Dimensions and weight

Model	Dimensions (mm)						Weight (kg)	
	H1	H2	H	D1	D2	CDME	CDMFE	
15-2	307	293	690	172	217	52	45	
15-3	362	345	797	197	227	63	55	
15-4	407	348	848	215	245	71	64	
15-5	452	348	890	215	245	73	66	
15-6	575	390	1055	260	263	95	88	
15-7	620	390	1100	260	263	96	89	
15-8	665	390	1145	260	263	103	96	
15-9	710	390	1190	260	263	104	97	
15-10	785	500	1375	330	325	165	158	
15-11	830	500	1420	330	325	167	160	
15-12	875	500	1465	330	325	168	161	
15-13	920	500	1510	330	325	170	163	
15-14	965	500	1555	330	325	171	164	
15-15	1010	500	1600	330	325	187	180	
15-16	1055	500	1645	330	325	189	182	
15-17	1100	500	1690	330	325	190	183	
15-18	1145	500	1735	330	325	192	185	

CDM(F)E20 Installation sketch

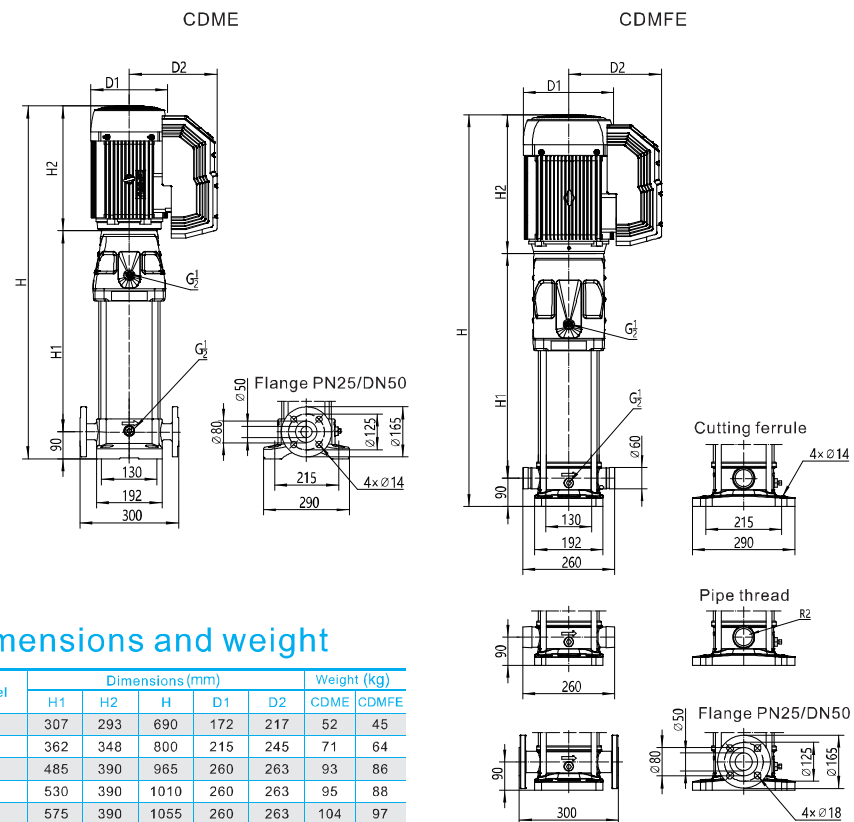

Dimensions and weight

Model	Dimensions (mm)						Weight (kg)	
	H1	H2	H	D1	D2	CDME	CDMFE	
20-2	307	293	690	172	217	52	45	
20-3	362	348	800	215	245	71	64	
20-4	485	390	965	260	263	93	86	
20-5	530	390	1010	260	263	95	88	
20-6	575	390	1055	260	263	104	97	
20-7	620	390	1100	260	263	105	98	
20-8	695	500	1285	330	325	175	168	
20-10	785	500	1375	330	325	178	171	
20-12	875	500	1465	330	325	196	189	
20-14	965	500	1555	330	325	199	192	

CDM(F)E32 Installation sketch

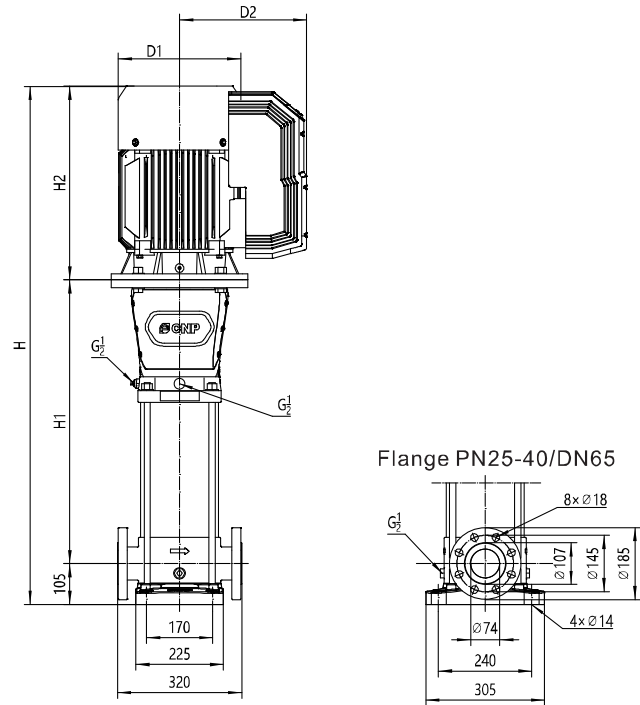

CDM(F)E42 Installation sketch

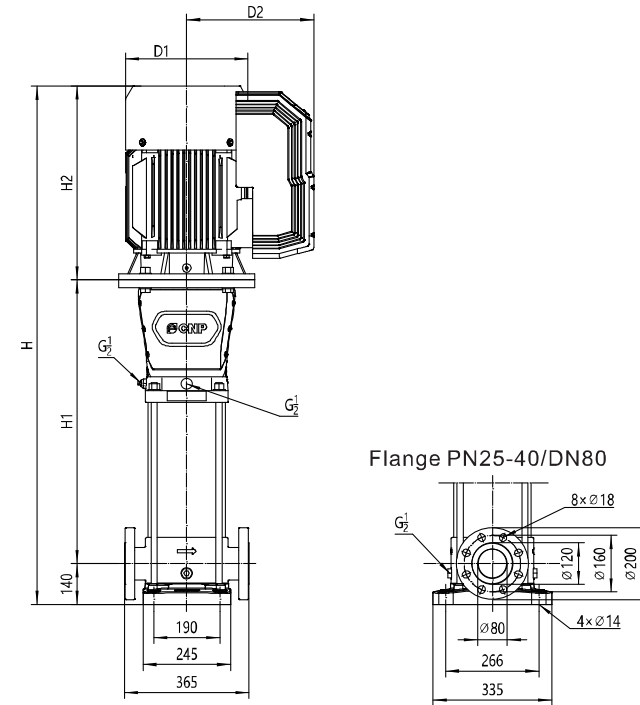

Dimensions and weight

Model	Dimensions (mm)					Weight (kg)	
	H1	H2	H	D1	D2	CDME	CDMFE
32-1-1	329	293	727	172	217	70	58
32-1	329	293	727	172	217	72	60
32-2-2	399	345	849	197	227	77	73
32-2	399	348	852	215	245	84	80
32-3-2	560	390	1055	260	263	107	103
32-3	560	390	1055	260	263	107	103
32-4-2	630	390	1125	260	263	118	114
32-4	630	390	1125	260	263	118	114
32-5-2	730	500	1335	330	325	192	187
32-5	730	500	1335	330	325	192	187
32-6-2	800	500	1405	330	325	194	190
32-6	800	500	1405	330	325	194	190
32-7-2	870	500	1475	330	325	212	208
32-7	870	500	1475	330	325	212	208
32-8-2	940	500	1545	330	325	215	211
32-8	940	500	1545	330	325	215	211

Dimensions and weight

Model	Dimensions (mm)					Weight (kg)	
	H1	H2	H	D1	D2	CDME	CDMFE
42-1-1	350	345	835	197	227	87	77
42-1	350	348	838	215	245	95	85
42-2-2	521	390	1051	260	263	118	108
42-2	521	390	1051	260	263	126	116
42-3-2	631	500	1271	330	325	200	190
42-3	631	500	1271	330	325	200	190
42-4-2	711	500	1351	330	325	219	209
42-4	711	500	1351	330	325	219	209

CDM(F)E65 Installation sketch

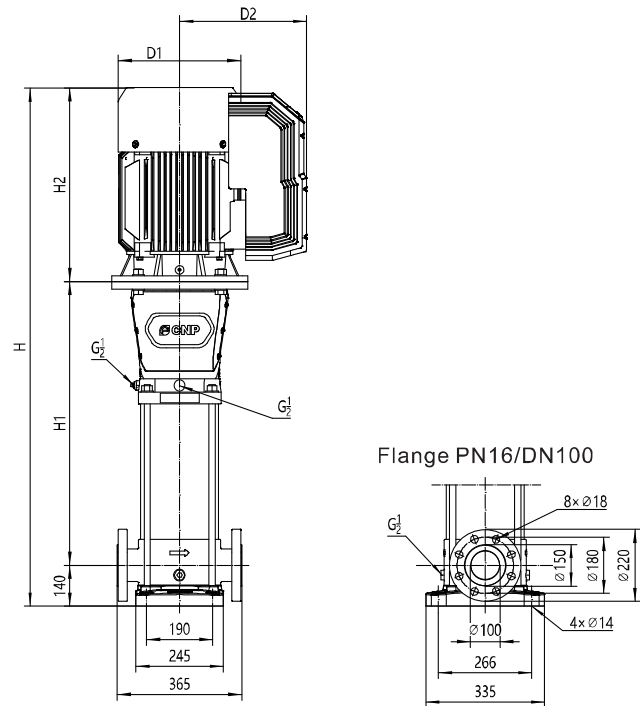

Dimensions and weight

Model	Dimensions (mm)					Weight (kg)	
	H1	H2	H	D1	D2	CDME	CDMFE
65-1-1	353	348	841	215	245	106	75
65-1	444	390	974	260	263	126	95
65-2-2	527	390	1057	260	263	138	107
65-2-1	557	500	1197	330	325	209	178
65-2	557	500	1197	330	325	209	178
65-3-2	640	500	1280	330	325	227	196
65-3-1	640	500	1280	330	325	227	196